



Your Performance Partner

Networking Instructions

Transform™

# Motorized Acoustical Banner



## Contents

Introduction .....	2	Power Requirements .....	8
Networking Details .....	3	Programming .....	9
Banner Controls .....	7		



Visit the Transform Motorized Acoustical Banner web page at [www.wengercorp.com](http://www.wengercorp.com) for detailed instructions and videos.

**Note:** Please read and understand the instructions before starting the assembly or installation.

**Note:** If you need additional information, contact Wenger Corporation using the information below.

## **Introduction**

---

This document is provided to give the buyer/user/installer information to assist in the specification and installation of a Transform Banner system.

It details system requirements and suggests methods of operation to maximize functionality and user friendliness.

**Note:** Regardless of if the banners are to be installed by Wenger or by others, the physical wiring providing power for the banners and the physical wiring for the control network with suitable outlets is the responsibility of the buyer/owner.

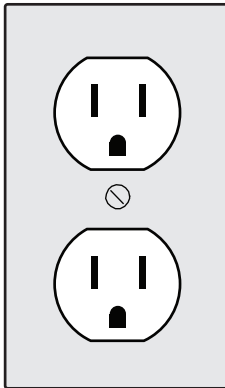

**Standard  
Power Receptacle**

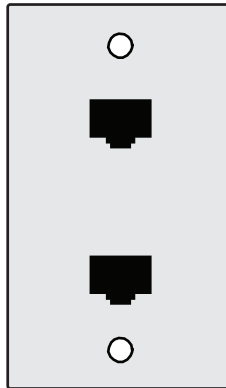

**Dual  
RJ45 Receptacle**

## Networking Details

The entire Wenger Transform Acoustical Banner system works on a single serial network of motors and controls.

CAT 5 (or better) cable is run around the room near each network component. Switches and motors simply tap into that cable creating the network.

A typical circuit might look like this:

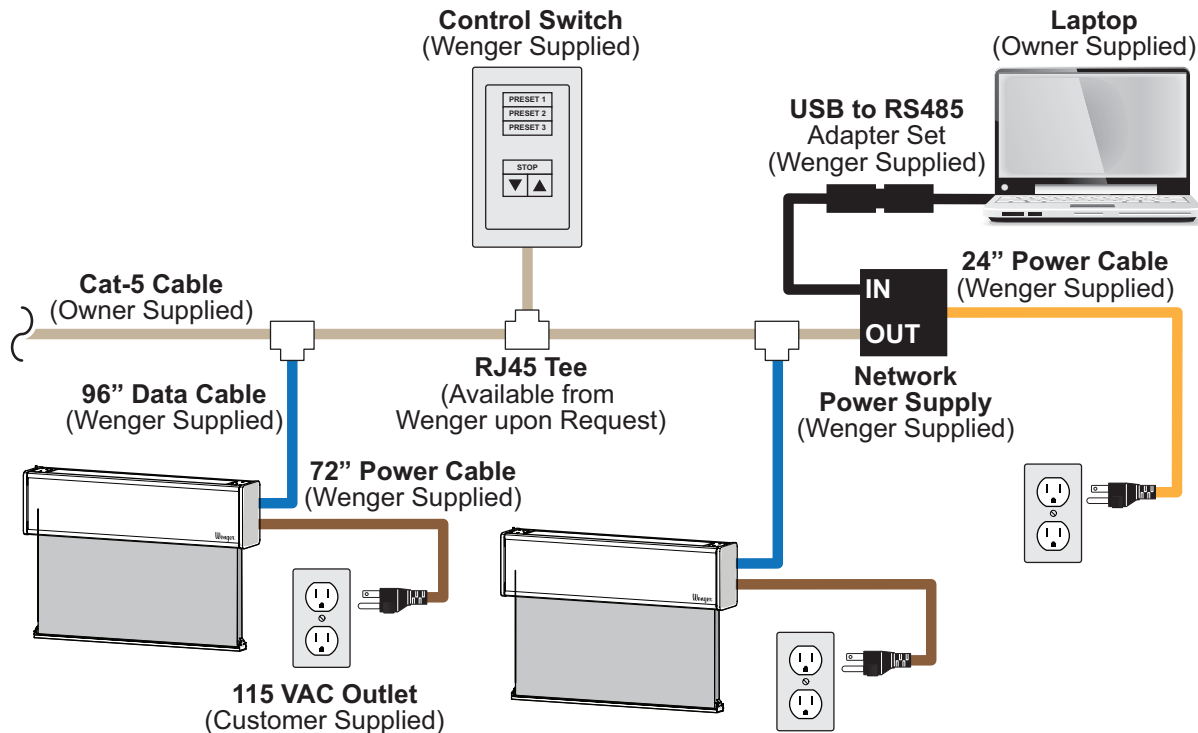

This diagram shows all of the necessary components in a banner network:

Component	Quantity
Acoustical Banner	1 or more
Control Switches	1 or more
Power Supply	Only 1
Laptop with Adapter Set (used for set-up and maintenance only)	Only 1

It is recommended that all AC power to the banner motors and the network power supply remain off until all network components are connected and installed.

### **CAUTION**

**To prevent unanticipated motor actuation, disconnect power from all banners until all network components are installed and connected.**

Avoid putting unnecessary stress on the control switch's RJ45 connections by using electrical boxes that are too small.

Junction boxes at a minimum of 3-1/2" deep are recommended for wall control switches.

## **Networking Details (continued)**

---

Any number of banners and control switches can be on a network. Each network requires only one power supply which can be positioned anywhere on the network.

The main networking caveat is that the programming laptop computer must be plugged into a RJ45 jack in the power supply (and not directly into the network), it is advised to have the power supply accessible for this temporary/occasional connection.

The customer supplied laptop is only required for initial commissioning, fine tuning, potential maintenance and operational changes.

It does need to remain connected to the network during normal operation.

Connections at all network components are made with RJ45 connectors.

There are plugs on the banners and jacks in both the switches and power supply.

The interconnection cable (not supplied) should be CAT 5 or better.

Common ethernet cables work well with this system.

The maximum cable length in a single network is 4,000-feet.

No special end termination is required at the ends of the serial network.

Wenger can supply the RJ45 Interconnection Tees (if requested) to interconnect standard pre-terminated CAT 5 cables however that connection is often made at the jacks by the networking electrician.

**NOTE:** Whether the network is hard-wired on site or employs prefabricated cables with RJ45 connectors and tees, a good quality network is essential for proper banner operation. Many operational issues can be traced back to improper, dirty, open, shorted, painted or loose connections.



**RJ45 Receptacle  
(Customer Supplied)**



**RJ45 Tees  
(Wenger Supplied, if specified)**

## Networking Details (continued)

There are two standards commonly employed in CAT-5 cable networks, EIA 568-A and EIA 568-B. The two standards differ in that they reverse where pair 2 (orange) & pair 3 (green) are pinned. As it happens, these are the only wires that are used in network cables. Network protocol does not use pair 1 (blue) or pair 4 (brown).

Both standards are completely compatible with all Transform Banner network equipment and each other. You can plug a 568-A cable into a 568-B jack. The only difference is the insulation color of the wire the signals will travel, and electrons don't care about that. As long as both ends of a cable are wired to the same standard, the cable will work.

However, if you wish to choose a standard, Wenger recommends the 568-B because most off-the-shelf cables/equipment is wired to the 568-B standard.

**NOTE:** No crossover cables should be employed anywhere in the Transform banner network as they will disable the network. All cable conductors must terminate at the same terminal number on BOTH ends of each cable.

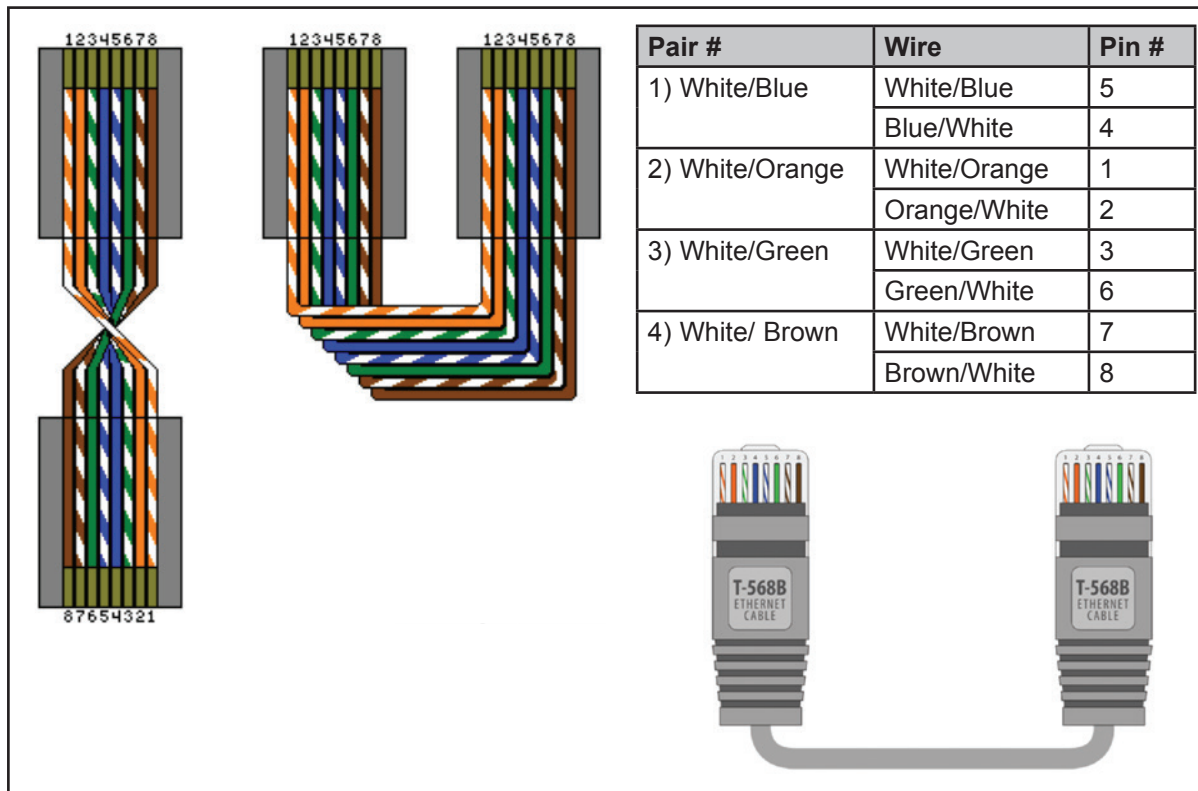

Cable to RJ-45 Connection

## Networking Details (continued)

If you are unfamiliar or uncomfortable with the proper installation of CAT-5 network cabling, Wenger recommends employing off-the-shelf pre-terminated network cables with the RJ-45 connectors already installed.

All network connections can then be made with simple Tee's available from Wenger.

The CAT-5 network cabling itself is not available through Wenger and should be purchased locally. With this option, no wiring of individual conductors is required.

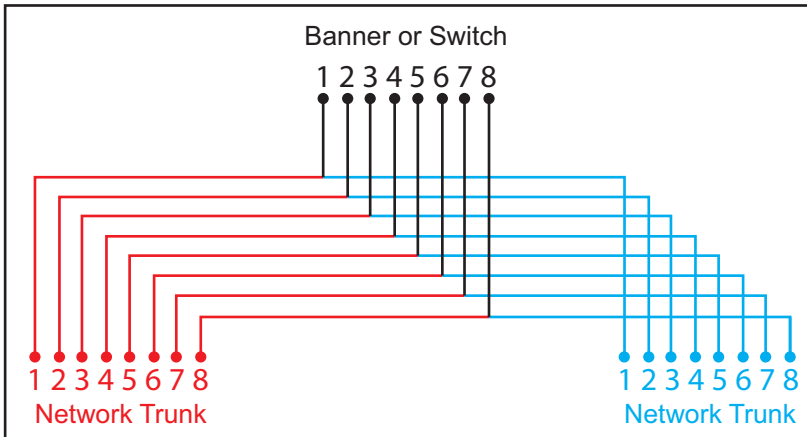

Cat-5 Banner Connection (typical)

The power and controller connections exit the banner assembly together at one end.

Banners with optional end covers will have raceways that route the cables upward exiting at the top of the banner at one end. Banners can be ordered as either Right Hand or Left Hand assemblies (dictating which end that the power and network cables are on) so that two banners in close proximity can share a single duplex outlet and network junction box with two RJ45 jacks.

The standard power cable length is about 80" long. The standard network cable is about 96" long from where it exits the motor.

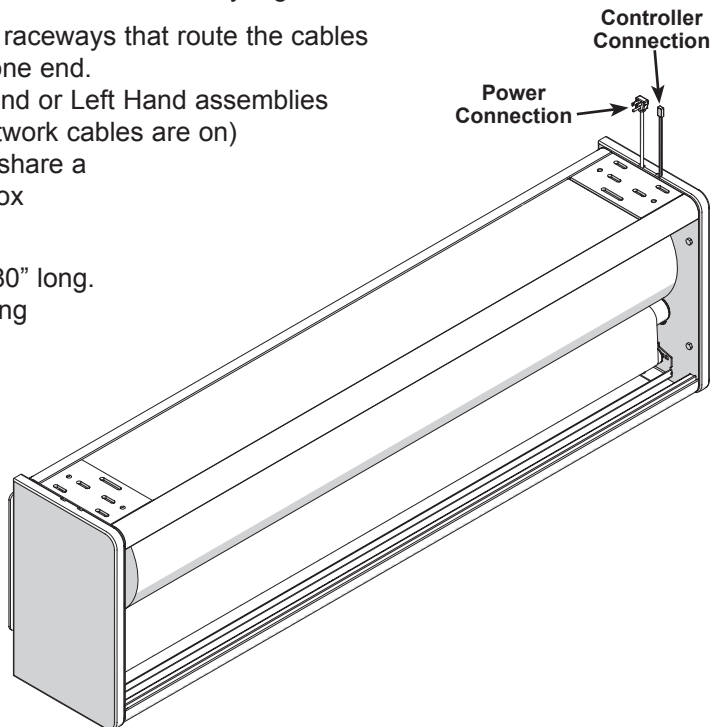

## Banner Controls

The controls come with Decora cover plates and fit in standard 2x4 single-gang boxes; 2.5" deep minimum.

Any number of switches can be installed in the network depending on the application's control needs. All controls can be placed anywhere along the network trunk line. They do not need to be grouped together.

These switches are not password protected so any necessary access control must be by external means. This could be through the use of aftermarket locking covers or placing them in access controlled spaces. The banner controls should be located within view of the banners for effective monitoring.

Wenger offers two standard control panels.

One is a 6-button switch; the other 8-button switch.

Both controls are available in white only.

Standard push buttons are labeled with "PRESET 1, 2, 3 etc.", "STOP" and up/down arrows as shown.

Custom engraving of buttons is available.

Maximum text length:

Large buttons - 9 characters. Small buttons – 5 characters.

Blank (unprinted) buttons are available.

**Any one button should always be reserved for a STOP function.**

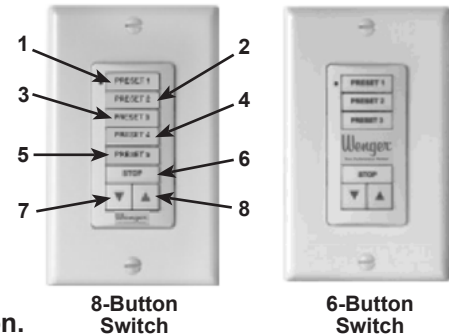

These control panels provide a cost effective, stand-alone control solution adequate for most applications. When necessary, the banner network can also be integrated into J.R. Clancy's Scene Control, Crestron, AMX controls or other theatrical/facility control systems upon request.

One simple option for interfacing the banner system with other control systems is to make use of the contacts on the back of the control switches. These are in addition to the RJ45 jack on the back of the switch that connects it to the Wenger network.

The interface is with a pair of 5-pin Phoenix connectors (included).

This provides a total of eight dry contact INPUT connections with two COMMON terminals, one in each connector.

Each input is numbered to correspond with and mimic the function of the push buttons with a dry contact closure. Shorting a contact at the connector to a common terminal is the functional equivalent of pressing the button of the same number.

When viewed from the front face of the control switch, the buttons are numbered 1 thru 8, top to bottom with the lower right switch being number 8.

On the 6-button switches, buttons 4 and 5 remain included in the numbering scheme but are nonfunctional.

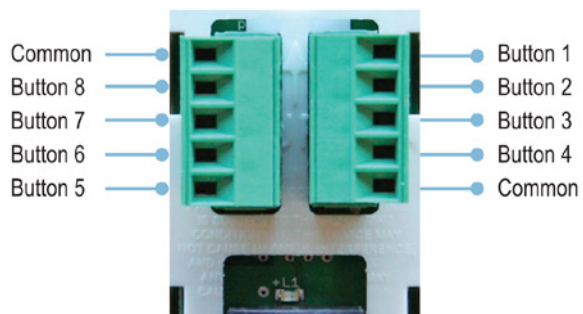

Detail of Inputs

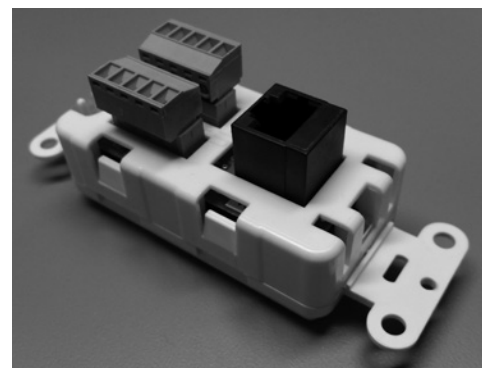

Control Switch

## **Power Requirements**

---

The banner motors are individually plugged into house power using standard plugs and receptacles.

The standard banner motor is rated at 120 VAC - 60 Hz, 2.1 amps maximum. (Other motors to accommodate world-wide electrical systems are available.) Current draw for a typical banner with a 115 VAC motor is about 1.5 amps each.

Each motor comes with a molded-on, 90-degree angle plug that mates with a standard 115 VAC, 5-15R electrical outlet.

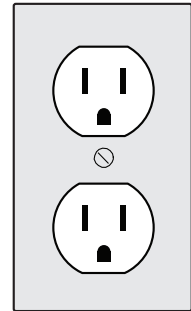

**Standard  
Power Receptacle**

A power supply is required to power the control circuit (similar to that used by laptop computers).

A single power supply will operate a banner network of any size.

It plugs into a typical 115 VAC 5-15R outlet.

The power supply is rated at 100-240 VAC – 50/60 Hz – 0.75 Amps maximum. It comes with a detachable power cord.

The power supply measures approximately 1.5" x 2.5" x 3.5".

There are no mounting holes, the use of double-stick or hook and loop tape to firmly attach the power supply is recommended.



**Power Supply**

In addition to the removable power cable receptacle, the power supply box has two RJ45 jacks for network interfacing. One jack is used to connect the power supply to the network and the other is used only for interfacing with a laptop computer.

The power supply should be located such that it can be easily accessed for attaching the laptop to enable occasional banner adjustments. (If not practical, a CAT 5 cable should be permanently run from the Input port on the power supply to a convenient laptop location.)



## Programming

---

1. The owner should reserve a laptop and have downloaded both the motor and control switch software before the planned installation date. For Wenger installed systems, the owner's laptop must be used for final adjustments so Wenger can ensure proper functionality. Programming can be performed by the contractor/owner or by Wenger (by special arrangement). Each control and motor must be programmed on site using software that is downloadable from the Wenger website.

Start by separately downloading both the motor and control switch software sets from:

<https://www.wengercorp.com/acoustics/transform-motorized-acoustical-banner.php>

2. Connect the laptop to the banner network.  
The USB to RS485 adaptor set has a USB connector on a short cable that plugs into a Windows laptop.  
The other end of this adaptor set has a RJ45 jack.  
Use an Ethernet cable (with RJ45 plugs on each end) to connect this adaptor to the Input port of the power supply.

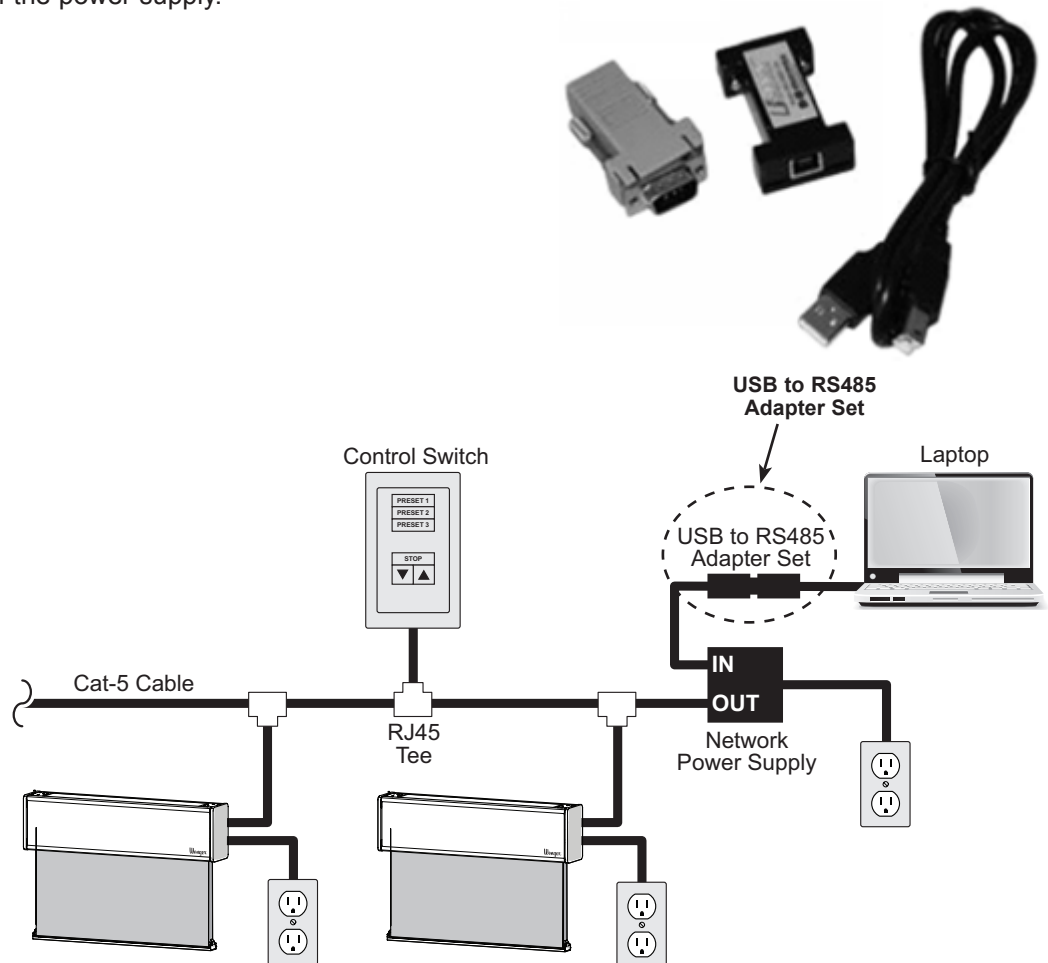

## Programming (continued)

- As received, the banner control switches have no functionality. They must be programmed as each button can be assigned numerous different functions that could be useful in various banner applications.

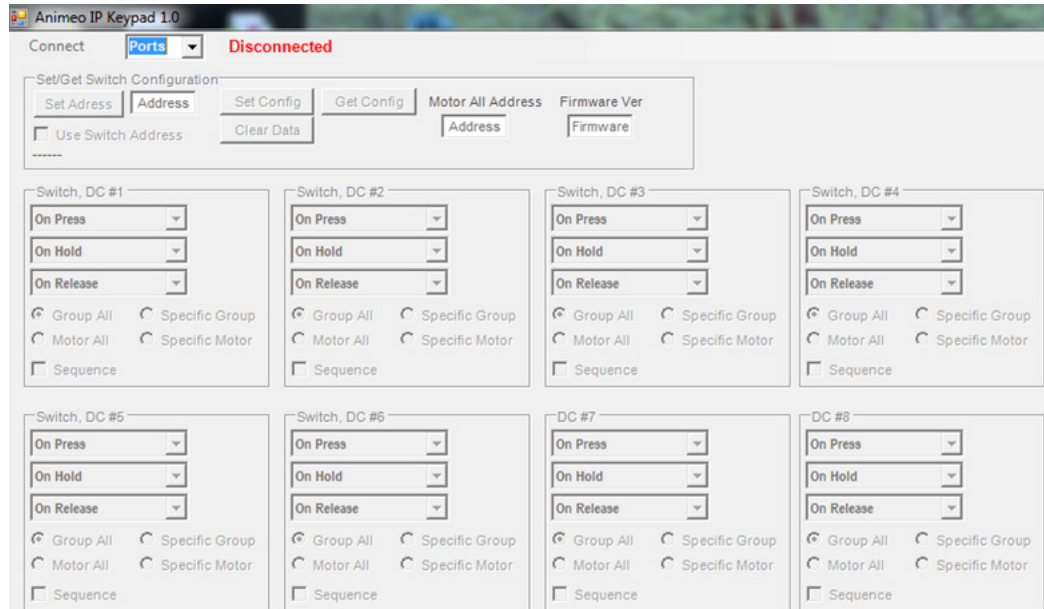

Similarly, the banner motors may have generic limits assigned but no intermediate positions or motor groupings are assigned.

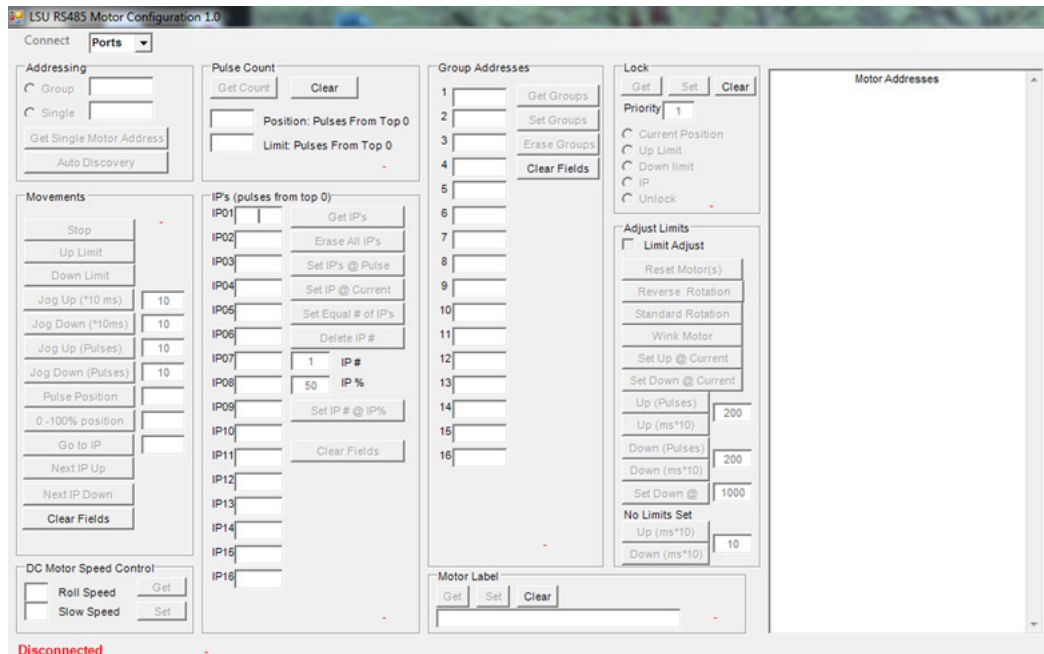

## ***Programming (continued)***

---

4. Either the 6-button or 8-button switches can be programmed in a variety of ways. Pressing a button can send any number of banners to their upper limit, lower limit or any of 16 customizable intermediate positions.

They can be programmed such that a momentary press and release of a button will latch the motor on, causing the motor to run until the banner reaches its destination position and automatically shuts off.

They can also be programmed “dead man” meaning that the button has to be held depressed in order for the motor to run. Though being held on, the motor still automatically shuts off when the banner reaches its programmed destination position.



8-Button Switch



6-Button Switch

5. While all buttons are completely programmable, each control switch comes with and should always maintain a STOP button. The remaining buttons can be programmed to best fit the needs of the application and the user. Unneeded buttons can be disabled so they have no function.

Blank (unprinted) buttons are available.

### **CAUTION**

***Each control switch should contain a functional STOP button programmed to stop all motion of all banners; even those not otherwise controlled by that particular control switch.***

## Programming (continued)

---

6. The banner control system is very versatile and allows the user to control the banners in a variety of ways. Any number of presets can be programmed by adding additional switches to the network. Using a literal “functional” approach, a push button on the control can simply be programmed to send a banner (or banners) to a specific position (like “House Left Down”). Pressing another button would send them to a different position.

7. Another mode of operation allows a “garage door” function where pressing a single button causes the banner(s) to go up. Pressing the same button again sends the banner(s) back down.

8. A more intuitive approach; our recommendation is to think about the program source and NOT the banners themselves. For instance, one button labeled “SPEECH” could be programmed to set up the venue for spoken word programs. Pressing the button would appropriately position all banners in the network (likely all down) for minimum reverberation in the space. Another might be for CHORAL programs where the banners are more likely to be up to increase the reverberation time in the room. Similarly, an ORCHESTRA preset could position the banners best tuned for the acoustics of that program source.

Using this method, the operator does not need to think about (nor even understand) the acoustics of individual banner placement.

The venue will automatically be set for optimum acoustics by pressing a single button reflecting only the type of program being performed.

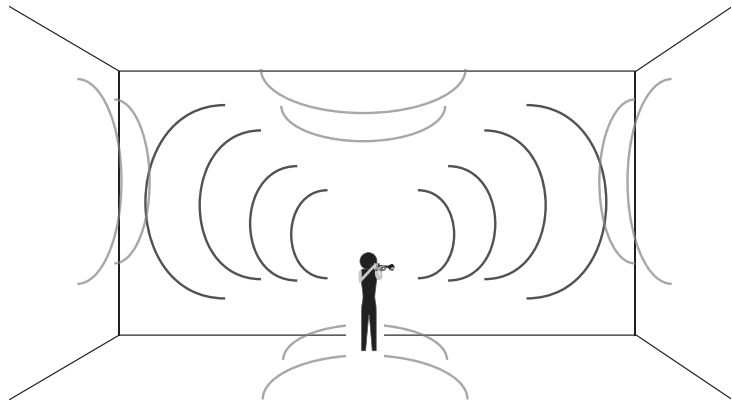
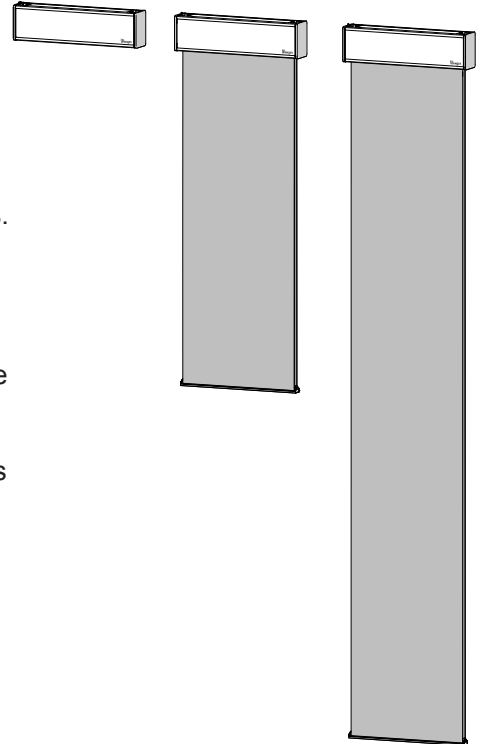

**For additional information:**

**See the original Transform Motorized Acoustical Banner Installation Instructions 213A099 or visit <https://www.wengercorp.com/acoustics/transform-motorized-acoustical-banner.php>**